

Study of Energy Absorption in Automobile Light Weight Composites Subjected to Impact: Numerical-Experimental

M. Mokhtari^{1*}, K. Farhadi²

¹Master of science in Mechanical Engineering, Ghandi Center of Research, K.N.T. University of technology*
²Research Professor, Polymer Institute

*m.m1988@yahoo.com

Abstract

Automobile light weight structural composites are subjected to the various loadings in their service lives. Honeycombs are increasingly used as core structures in automobile light weight structures as energy absorbers. In this paper the energy absorption of honeycomb panels under impact of cylindrical projectile is numerically and experimentally studied. The effect of the core materials and cross-ply or semi-isotropic lamination of face-sheets are checked numerically. Results shown that the aluminum cores vs. Nomex cores and semi-isotropic lamination of face-sheets have much better energy absorption aspects in impact loading.

Keywords: Sandwich composites, Impact, Numerical- Experimental

1. Introduction

Honeycombs are extensively used as energy absorbers, because of their individual properties like their light weight, good energy absorption and high flexural strength [1-5]. Sandwich panels with honeycomb core are used in transportation and aerospace industries because of their high stiffness and specific strength. Honeycombs are impacted in different situations by projectiles, and the impact damage varies from indentation of sandwich skins to complete perforation of the panel. Therefore, the study of structural behavior of honeycombs is a high demand of advanced industries. The first study of honeycomb crush was done by McFarland [6] who proposed a semi empirical model to predict the crushing strength of cellular structures with hexagonal cells. This model was then developed by other researchers considering the bending and extensional deformations. Wierzbicki [7] introduced an angle element to predict the crushing load of honeycombs under quasi static axial loading. Abramowicz and Wierzbicki [8] modified this model for axisymmetric and asymmetric deformation modes. The honeycombs response to quasi static and impact loads were experimentally studied by other researchers [9–11]. Perforation of sandwich panels with honeycomb core by projectiles was studied analytically by HooFatt and Park [12]. The impact behavior of a sandwich panel depends on many

factors, not only the mechanical properties of its constituents, skins and core, but also the adhesive capacity of the skin-core interface. The high-velocity impact behavior differs from the low-velocity one, and therefore the conclusions drawn in studies on low-velocity impacts are not applicable to high-velocity cases. In this way, a high-velocity impact is a phenomenon controlled by wave propagation, and is essentially independent of boundary conditions, whereas a low-velocity impact is highly influenced by the boundary conditions. Numerous failure criteria which consider several damage mechanisms have been used in the bibliography to analyze the failure of composite structures, such as the Hashin–Rotem criteria [13], Chang–Chang criteria [14], Puck criteria [15], Houcriteria [16] or Larc criteria [17].

The understanding of automobile composite structures behaviour under impact conditions is extremely important for the design and manufacturing of these engineering structures since impact problems are directly related to structural integrity and safety requirements.

Wekezer et al. [18] was modelled the high speed impact in automobile composite structures and improved the impact simulation between vehicles and roadside safety hardware with DYNA3D, finite-element code. Also, Kim et al. [19] was studied the Spherical-shaped ice simulating hailstones were projected onto woven carbon/epoxy composite panels to determine the damage resistance. The impact velocity of hails was modeled between (30-200 m/s).

of thin-walled composite structures to ice impact, and to observe the resulting damage modes that occur over a wide range of velocity

In this study high velocity simulation of impact between hard materials and vehicle composite structures is investigated. So, a preliminary example problem of an imp actor and a composite plate is used to model an impact between two deformable bodies and the energy absorption of honeycomb panels under impact of cylindrical projectile is numerically and experimentally studied. The effect of the core materials and cross-ply or semi isotropic lamination of face-sheets are studied numerically.

2. Experimental Tests

To validate the numerical model, several high-rate impact tests were carried out on 4 specimens 140 mm in length, 140 mm in width, and 24 mm in thickness

(as shown in Fig.1). These tests were performed using a gas gun that schematically is shown in Fig. 2. The specimens were impacted by cylindrical steel projectiles of 1.7 g and 7.5 mm in diameter. The distance of the gas gun outlet and test fixture is about 10 meters. The specimens were fixed to their fixtures as shown in Fig.1. For an impact velocity of 94 m/s the primary and secondary velocities of specimens was gathered from the tests and used to estimate the projectile energy dissipation. Schematic representation of the experimental setup for impact is shown in Fig.2. These four specimens were sandwich panels with aluminum cores in the three cases and Nomex core at the other case with Kevlar-49/ epoxy face sheets (mechanical properties of the face-sheets is shown in Table. 1). Also, the projectile penetration (projectile with 94 m/s velocity) in specimen with aluminum cores and Kevlar-49/ epoxy face sheet is shown in Fig. 1.

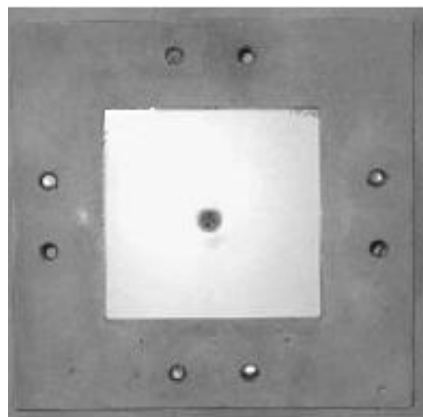

Fig1. The schematic of test fixture and mounted specimen(140 mm×140 mm and 24 mm thick)

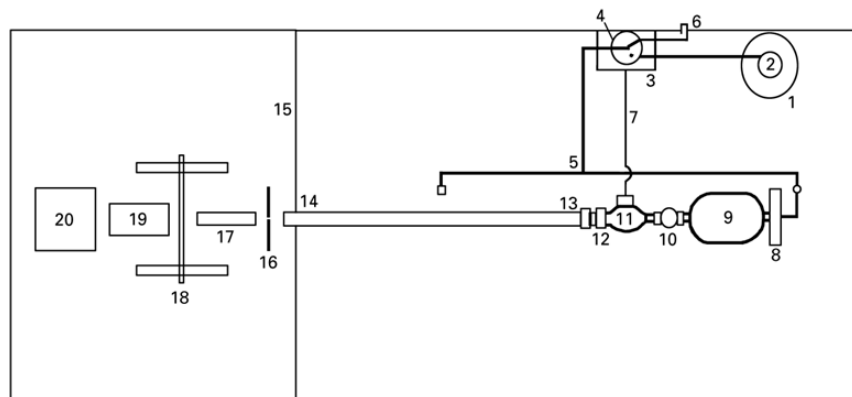

Fig2. Schematic diagram of the gas gun and test setup: (1) gas bottle, (2) gas regulator, (3) control box, (4) three-way valve, (5) gas line (two barrel connections), (6) gas vent line, (7) solenoid activation cable, (8) pressure gauge, (9) pressure vessel, (10) leak valve, (11) solenoid valve, (12) ball joint, (13) breech, (14) barrel, (15) hardened wall, (16) blast screen, (17) incident velocity device, (18) target support stand, (19) exit velocity device, (20) catcher box.

(a) and (b) subscripts of Fig.3.

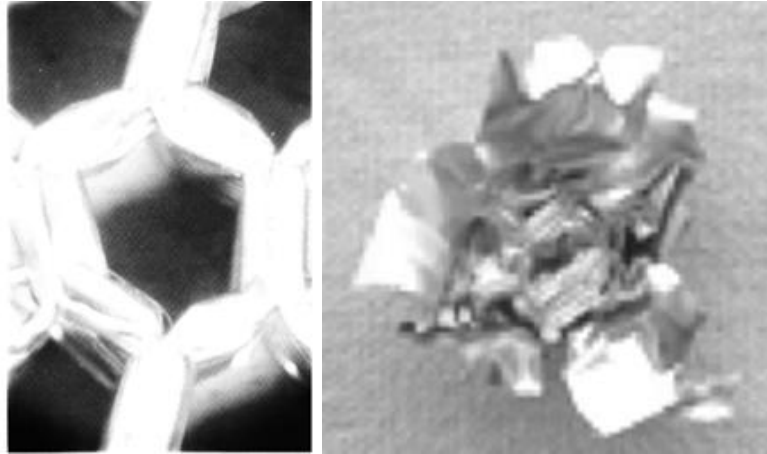

Fig3.(a) Crushed aluminum honeycomb core near the penetrated region
 (b)Produced plug from aluminum honeycomb core at 94 m/s impact velocity

Table.1Mechanical properties of Kevlar-49/5052 [20]

E_1 (GPa)	E_2 (GPa)	G_{12} (GPa)	ν_{12}	S_{ut} (MPa)	S_{uc} (MPa)	S_{us} (MPa)
130.5	130.5	3.7	0.2	795	860	98

Table 2. Mechanical properties of the aluminum core and Nomex core [17]

	σ_{comp} (MPa)	σ_{crush} (MPa)	E_{comp} (MPa)
Aluminum core	3.76	1.8	400
Nomex core	2.57	1.5	430

Fig4.The schematic geometry properties of modeling

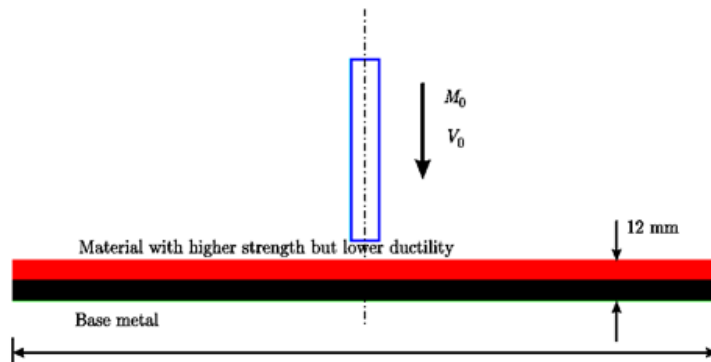

The corresponding top view is presented in Fig. 3 (a). The buckling configurations of aluminum honeycomb near the area of the hole were regular; furthermore, the buckling geometry was the same throughout the specimen thickness. While these failure modes are uniform in the three directions perpendicular to the cell walls, they differ from each other. Fig. 3 (b) shows produced plugs in these panels.

3. Numerical Modeling

The finite element model used to analyse the sandwich impact behavior was implemented in ABAQUS/Explicit. Since the influence of boundary conditions is negligible in the impacts with high rates, the FEM3D model included two solids: a projectile and a sandwich plate. Because of plastic deformation was found in the projectile after the experimental test, plastic behavior was used for the steel CK 45 projectile ($E=200$ GPa, $\nu=0.3$, Elongation at break=15%). The honeycomb core was modeled by a homogeneous equivalent material as shown in Table 2.

According to ABAQUS recommendations to remove elements from the mesh as they fail, the material definition also includes failure models with progressive damage. So, both the ductile and shear initiation criteria are used: the ductile criterion is specified in terms of the plastic strain at the onset of damage as a tabular function of the stress triaxiality; the shear criterion is specified in terms of the plastic strain at the onset of damage as a tabular function of the shear stress ratio.

In this work, square sandwich specimens (140 mm \times 140 mm and 24 mm thick as shown in Fig. 4) were used. The skins were plain woven laminates of Kevlar-49 fibers and epoxy resin 5052 and with 2 mm thickness. The core was a 3003 aluminum honeycomb of 10 mm thick and 72 kg/m³ in density. The cells were hexagonal, with 4.8 mm in cell size and wall thickness of 0.6 mm. The properties of the composite skins and the honeycomb core that was used in numerical model were determined by characterization tests and literature. The properties of the Kevlar-49/epoxy woven laminate and core material are shown in Table 1 and Table 2. For the comparison purposes the projectile aspects was modeled similar to experimental tests.

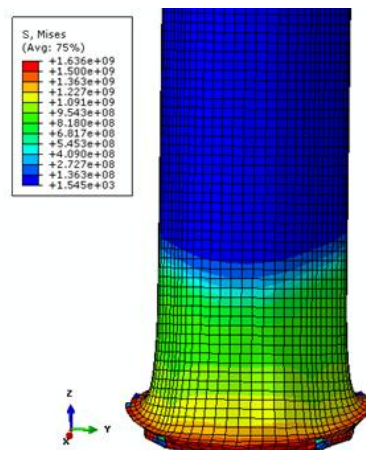

Fig5. Deformed projectile and Von Mises stress contour (MPa) of projectile head after 0.001 sec.

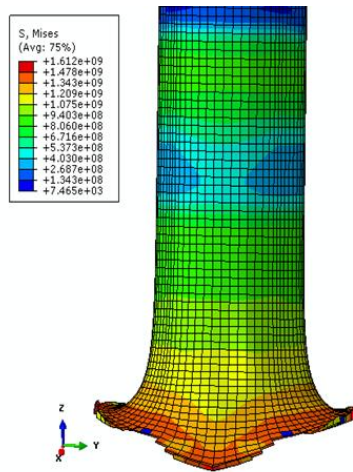

Fig6. Deformed projectile and Von Missess stress contour (MPa) of projectile head after 0.002 sec.

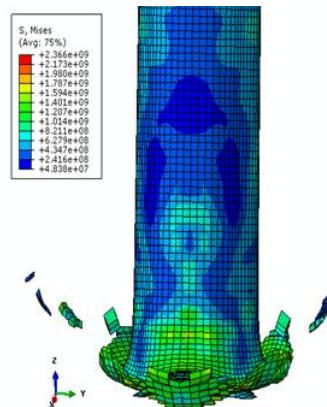

Fig7. Stress projectile and Von Missess stress contour (MPa) of projectile head after 0.04 sec.

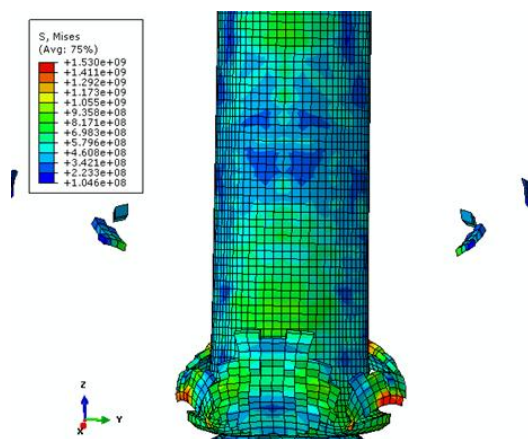

Fig8. Stress contour (MPa) in the projectile head in 0.07 sec.

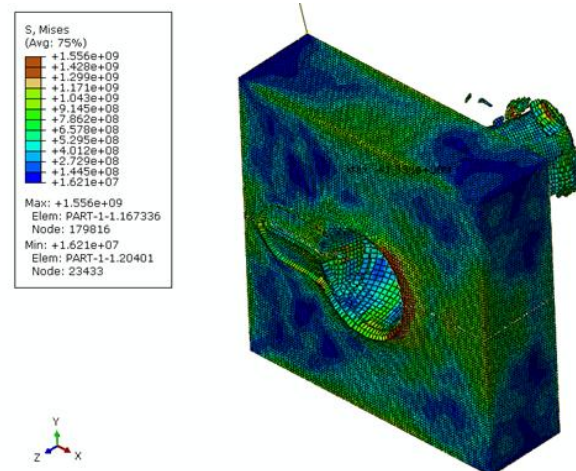

Fig9. Penetrated projectile in the light weight structure and stress contour (Pa) after impact time (0.07 sec)

A three dimensional non-homogeneous mesh was used. Successive space discretization were carried out to evaluate the sensitivity of the mesh. Finally, the selected mesh had 107,650 three-dimensional 8-node brick elements with reduced integration (C3D8R) in ABAQUS 6.12.

The results of the impact modeling in time increments are shown in Figures 5-8 and the penetrated model after projectile impact is shown on Fig. 9.

The projectile separated fragment parts, with 2 mm largest dimensions are clearly shown in Fig. 8 and Fig. 9

4. Model Validation

The numerical results were compared with the experimental ones to validate the finite element model. The variables selected to validate the numerical model was the absorbed energy. The comparison between absorbed energy in experimental and numerical cases are shown in Table 3. Numerical results were close to the experimental ones so that the precision of the model in the prediction of the residual velocity of the projectile was verified. The contact time was estimated at the time between the contact of the projectile with the front skin and the instant at which the projectile completely penetrated the sandwich plate and estimated in 0.07 sec.

5. Parametric Study

Core materials and semi-isotropic lamination were studied after the verification process. The effect of Nomex cores in comparison with aluminum core was

shown in Table 4 and the effect of face-sheets laminations were shown in Table 5.

6. Results

The drawback of the experimental impact tests was the limited information concerning the evolution of the projectile during the impact. The experimental tests provided information only about the velocity of the projectile before the impact over the front skin and after the perforation of the back skin. However, the finite element model showed the evolution of the projectile while it was crossing through the sandwich plate. There are three different trends corresponding to the three components of the sandwich (front skin, core, and back skin). In the first region, the composite front skin caused a sudden drop in velocity at the beginning of the impact event, so that the projectile reached the honeycomb core at a velocity of nearly 50 m/s. Secondly (25–60 m/s), the velocity remained almost constant as the projectile went through the honeycomb core, when the projectile reached the back skin, its velocity was nearly 45 m/s. In the back skin a new drop in velocity was observed for a residual velocity of over 35 m/s. The projectile lost 44% of its impact kinetic energy, front and back skins absorbed 43% and 40% of the absorbed energy, respectively, and the honeycomb core absorbed 13%. The skins were the main factor responsible for the energy adsorption, while the energy absorbed by the honeycomb core was lower. Also the honeycomb embeds the large deformations of the top skin and prevents large deformation of the sandwich panel. The percentage of the energy absorbed by each component was almost constant.

The use of the finite element model provides information about the failure modes in the perforation process. The main failure mode in the composite skins was fiber breakage. The energy absorption mechanism of the composite skins was based on fiber breakage. The energy needed to break high strength Kevlar-49 fibers was very high, so the projectile underwent a sudden loss of kinetic energy when it penetrated a composite skin. The main energy absorption mechanism of the honeycomb core was the plastic strain of the aluminum/Nomex walls. The energy needed to deform a thin-walled cell of Nomex

was very low and was lower than aluminum cores, so the projectile crossed the honeycomb core with no major loss of kinetic energy.

The experimental tests indicated that the region of the honeycomb over which the projectile impacted had a very small influence on the results. The impact wave is absorbed with honeycomb cells and the deformation of the second skins was reduced. The numerical simulations showed that the semi-isotropic face-sheets absorbed the impact energy 6.25% more than cross-ply laminations.

Table 3. Verification of the Modeling Results

	Experimental	Numerical modeling	% discrepancy
Absorbed energy in the sandwich panel (J)	5.2	4.8	7

Table 4. The Effect of Core Material of Sandwich Panel on the Energy Absorption

	Sandwich panel with aluminum core	Sandwich panel with Nomex core	% discrepancy (Based on aluminum core)
Absorbed energy (J)	4.8	4.2	12.5

Table 5. The Effects of Face-sheets Laminate Stacks on the Energy Absorption

	Sandwich panel with cross-ply Kevlar-49/5052 face-sheets	Sandwich panel with semi-isotropic Kevlar-49/5052 face-sheets	% discrepancy (Based on cross-ply lamination)
Absorbed energy (J)	4.8	5.1	6.25

Conclusions

In this study the perforation of composite sandwich panels subjected to impact was analyzed using a three-dimensional finite element model implemented in ABAQUS/Explicit. Experimental impact tests were carried out to validate the numerical model. Good agreement was found between numerical and experimental results; in particular, the numerical simulation was able to predict the amount of energy absorption of sandwich panel with a difference of 7%. The influence of both skins and the core in the energy absorption capabilities of the sandwich panel was studied. Most of the impact energy was absorbed by the skins. For impact velocity of 94 m/s, approximately 45% of the impact energy

was absorbed by the front skin and 40% by the back skin. The honeycomb core absorbed between 10 and 20% of the impact energy by plastic strain. Also, the energy-absorption mechanisms in both skins and the core were studied. The main mechanism in the skins was fiber breakage whereas in the core the mechanism was the plastic deformation of the aluminum wall. Both in the skins and the core, the damage was concentrated in a small area around the impact point. The aluminum core absorbs the impact energy about 12.5% more than Nomex core and the semi-isotropic face-sheets absorbed the impact energy 6.25% more than cross-ply laminations.

References

- [1]. Fortescue, Peter and Stark, John Ed .Spacecraft Systems Engineering .John Wiley and, New York, 1991.
- [2]. Hexcell .Hexweb-Honeycomb Sandwich design technology .hexcell, 2000.
- [3]. gEngineering mechanics of composite materials. Daniel Issac M, Rizkalla S. Oxford university pressz, 1994.
- [4]. Fiber composite structure for space application . Bansemir, H .Elsevier, 1998, vol. 38. Campbell, F.C .Manufacturing process for advanced composites .Elsevier, 2004.
- [5]. McFarland RK. Hexagonal cell structures under post-buckling axial load. AIAAJournal, 1963, 1(6), pp.1380–5.
- [6]. Wierzbicki T. Crushing analysis of metal honeycombs. International Journal of Impact Engineering; 1983, 1(2), pp. 157–74.
- [7]. Abramowicz W, Wierzbicki T. Axial crushing of multi-corner sheet metal columns. ASME Journal of Applied Mechanics; 1989, 56, pp.113–20.
- [8]. Wu E, Jiang W. Axial crush of metallic honeycombs. International Journal of Impact Engineering; 1997, 19(5/6), pp.439–56.
- [9]. Goldsmith W, Louie DL. Axial perforation of aluminum honeycombs by projectiles. International Journal of Solid and Structures; 1995, 32(8/9), pp. 1017–46.
- [10]. Goldsmith W, Sackman JL. An experimental study of energy absorption in impact on sandwich plates. International Journal of Impact Engineering; 1992, 12(2), pp.241–62.
- [11]. HooFatt MS, Park K S. Perforation of honeycomb sandwich plates by projectiles. Composites, Part A: Applied Science and Manufacturing; 31:889–99, 2000.
- [12]. Hashin Z, Rotem A. Fatigue criterion for fiber-reinforced materials. J Composite Materials, 1973; 7:448–64.
- [13]. Chang F, Chang K. A progressive damage model for laminated composites containing stress concentrations. J Composite Materials, 1987; 21:834–55.
- [14]. Puck A, Schurmann H. Failure analysis of FRP laminates by means of physicallybased phenomenological models. Compos Sci. Technol. 1998; 58:1045–67.
- [15]. Hou JP, Petrinic N, Ruiz C, Hallett SR. Prediction of impact damage in compositeplates. Compos SciTechnol, 2000;60:273–81.
- [16]. Davila CG, Camanho PP. Failure criteria for FRP laminates in plane stress.NASA/RM-2003-212663; 2003.
- [17]. B. L. Buitrago, C. Santiuste, S. Sánchez-Sáez, E.Barberoa, C. Navarro. Modelling of composite sandwich structures with honeycomb core subjectedto high-velocity impact. Composite Structures ,2010, 92: 2090–2096.
- [18]. J. W. Wekezer, M. S. Oskard, R. W. Logan, E. Zywicz, Vehicle Impact Simulation. Journal of Transportation Engineering, ASCE, Vol. 119, No. 4, July/August, 1993, pp. 598-617.
- [19]. H. Kima, D. A. Welchb, K. T. Kedward. Experimental investigation of high velocity ice impacts on woven carbon/epoxy composite panels. Composites: Part A, 2003, 34, pp.25–41.
- [20]. Reinforced Plastics, M.H. Beheshti, A.M. Readoost, Iran polymer institute, 1384.